

Product Information/ Installation Instructions

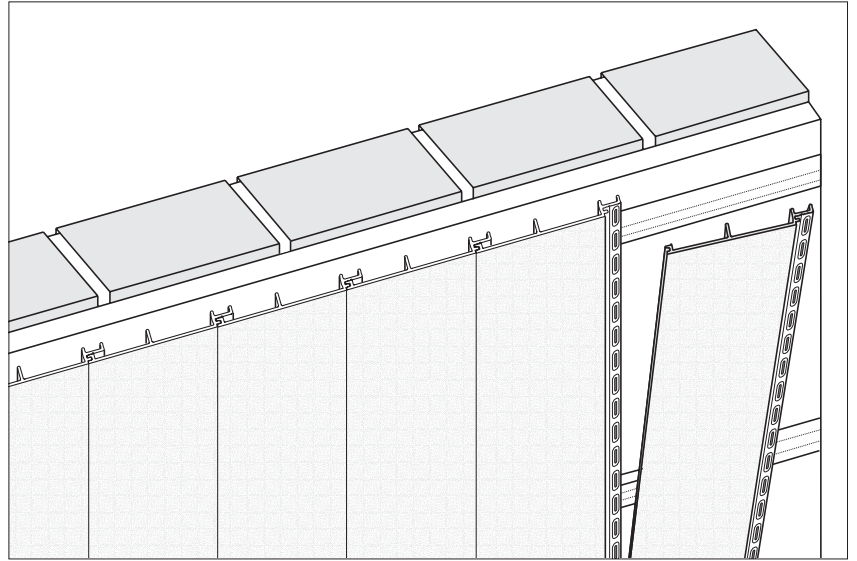

vinylTherm Stonechip Cladding

vinylTherm Stonechip Cladding panels are extruded using cadmium-free foamed thermoplastics. During the production process natural stone chippings are embedded into the surface resulting in a durable bond.

The manufacturing methods are state-of-the-art and include a strict procedure of continuous quality control.

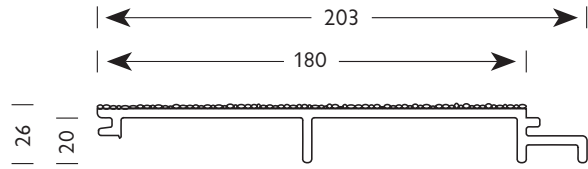

1. General Guidelines

vinylTherm Stonechip panels are packed in bundles of 6 pieces. When storing the packs, it is necessary to protect them particularly against moisture and dirt. Pallets of Stonechip panels can be stacked on the top of each other, but no more than four high.

Attention:

The pallets must be stacked with the vertical struts aligned. Pallets and individual bundles must be stored on level ground. Please ensure that during loading and off loading of the six meter long pallets, care is taken to ensure the panels are not damaged by the tines of the forklift truck.

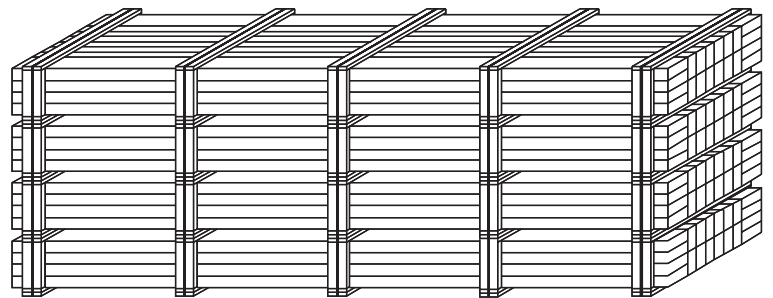

Transport should only be undertaken on vehicles with a six metre long bed. The supports on the sides of the vehicle should be removed prior to loading or unloading.

By observing these guidelines, it is possible to avoid damage during transportation and storage.

vinylTherm Stonechip panels are manufactured to DIN 4102, part 1 of building materials class B1. They are subject to continuous quality tests by the association of the Construction Material Research and Testing Association (MFPA) in Leipzig.



2. Colour Consistency of Stonechip Panels

vinylTherm Stonechip panels incorporate a surface layer of stone chippings a natural material, which means that slight colour variations are inevitable from batch to batch. Each individual batch is given an identifying code number, and material used on any particular elevation should originate from one batch. Never mix batches on an elevation.

Remainders of batches can be used on small projects such as annexes, garages, porches etc. Panels showing obvious signs of transport damage, production faults or colour variations, should not be used, but segregated prior to assembly.

Figure 1

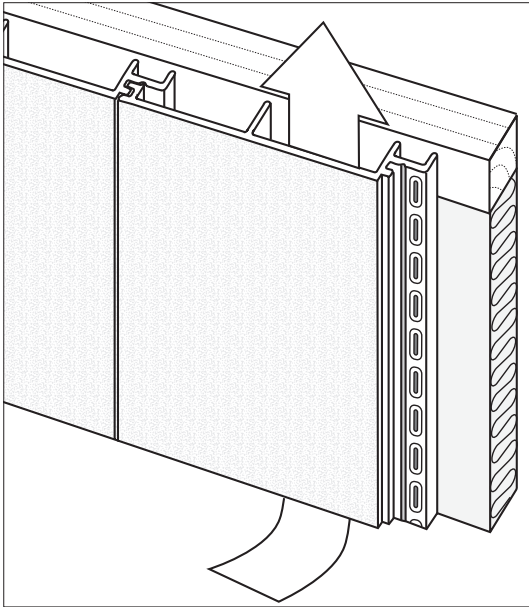

Figure 2

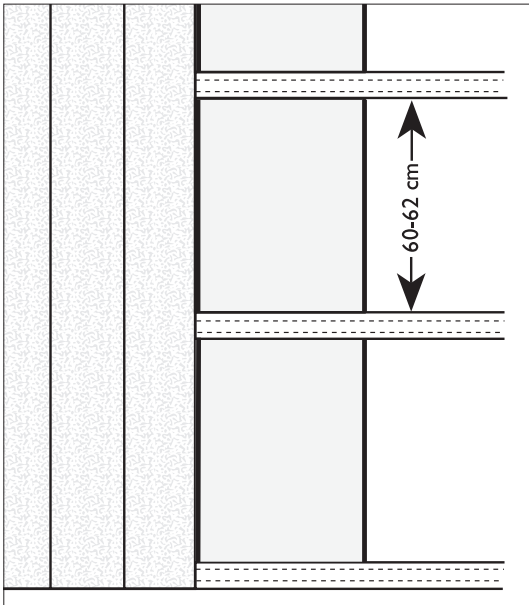
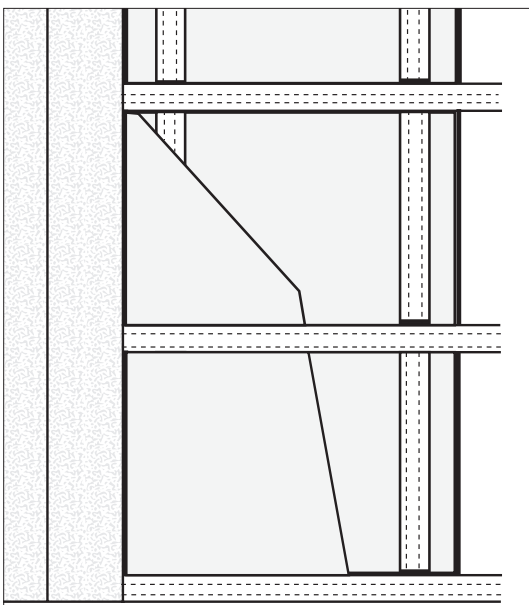

Figure 3



3. Ventilation

While assembling, please be aware of the need for continuous ventilation between façade panel and wall. This guarantees a reduction in air humidity and capillary separation of the cladding and the insulation material or wall surface, and prohibits mould growth. vinylTherm Stonechip cladding panels incorporate 20 mm high “legs” (Figure 1) which create the gap required for perfect through ventilation.

4. Assembly – Pre-planning

Before any panels are installed, we recommend that the building should be carefully measured. Please note the exact positions of windows, doors, corners and bays. This should avoid unnecessary cutting and fitting, and thus a more attractive visual appearance all over can be achieved.

5. Sub-Structure

The sub-structure of wooden battens is fixed to the base wall with suitable fixings. The battens should be treated with a suitable damp proofing and insect repellent. For a basic framework the battens should have typical dimensions of 50 x 50 mm but can be varied according to insulation thickness. The distance between battens should not exceed 620 mm (but can be less), and should be 5 mm less than the width of the insulation.

In the case of a framework with a thermal insulation layer, should the system be fixed to an absolutely even wall surface, the thickness of the battens and the insulation can be the same (Figure 2).

When fixing to a wall surface which is slightly uneven, the wooden framework used should be at least 20 mm thicker than the insulation material used.

In order to level out major unevenness a second batten framework should be used (Figure 3). It is essential to mount the vertical frame first and then the horizontal framework. The unevenness is then balanced out by inserting wedges and other strips. Because of the second framework, a further layer of insulation can be installed between the horizontal battens. This helps prevent any cold spots – heat bridges. The battens used for the second frame must be at least as thick as the second insulation layer. Make sure you have left enough roof cover.

6. Fabrication/Cutting

You will need the following tools to fabricate and install vinyTherm Stonechip Cladding: Chopsaw, jig saw, disk grinder and Stanley knife. For the installation of natural corners you should use a router.

7. Assembly

vinyTherm Stonechip panels are mounted vertically on to the framework and the tongue and groove interlock when pushed together.

Fixing to the wooden batten should be done through the recesses formed as guides using rust free screw with a semi domed head. These should be sunk at right angles to the cladding, and not over tightened. You will probably require 15 screws per square meter.

For the pull peak area (1–2 m wide marginal strip, over 8 m high) of buildings of up to 20 meter in height, the panels must be fixed with two screws to each fixing point.

For fixing through the Stonechip surface you should use rust free cladding nails (façade nail with rough shaft, 1,9 x 27 mm. Article number 51.04.02). This refers also to the installation of natural corners (see: Figure 5).



Semi domed rust free screw 4 x 40

for fixing of vinyTherm cladding panels and reveal profiles



Screw nail 2.8 x 50

for fixing of vinyTherm cladding panels and reveal profiles



Chipboard screw with tallow drop head 3 x 12

for starter profile



Facade nail 1.9 x 27

Stainless steel (for fixing of vinyTherm cladding panels onto offset batten and fabrication of natural corner)

Figure 4

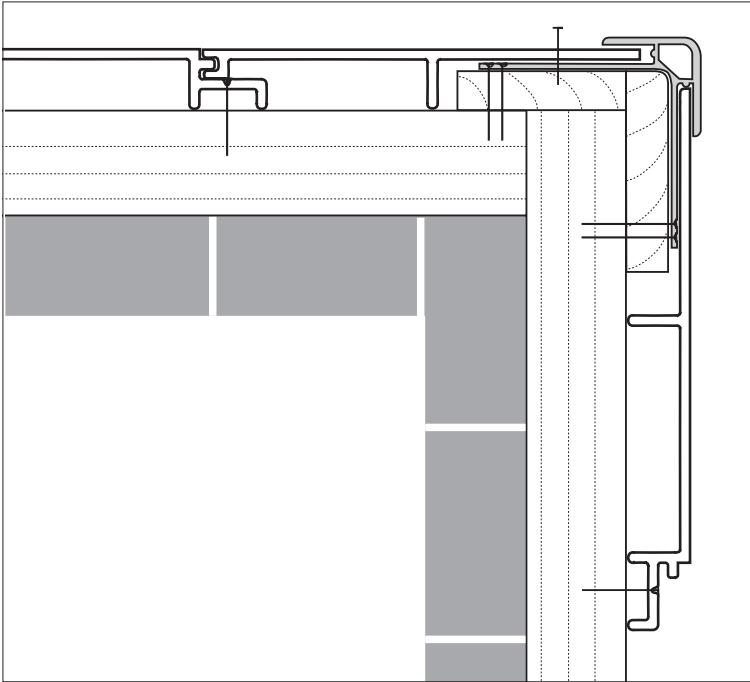

8. Assembly

a) External corner using a corner profile

To join Stonechip Cladding at an external corner (Figure 4), use the corner profile (Article number 21.07.11). Two vertical battens (30 x 20 mm) are screwed at right angles to each other onto the horizontal frame. The vinylTherm Stonechip panel must first have the groove leg removed and is then pushed into the receiving arms of the corner profile so that the cut edges are covered.

Figure 5

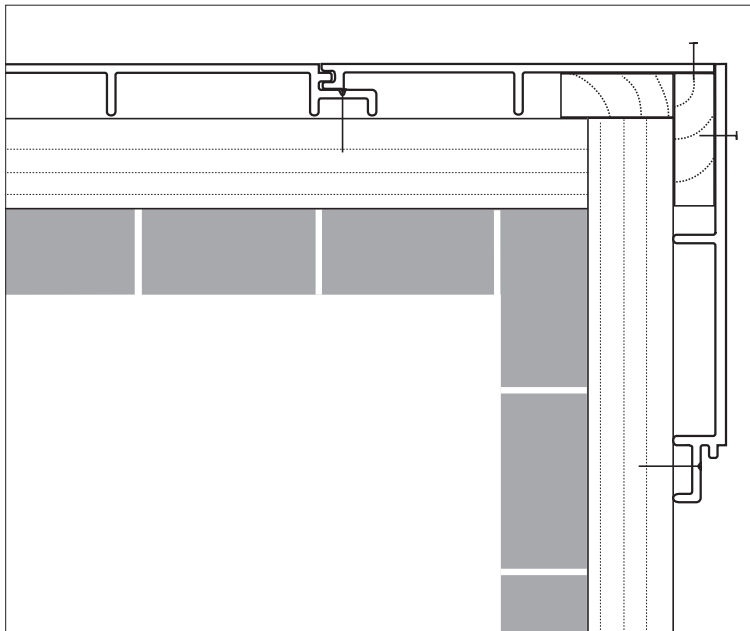

b) Natural corners

Should you want to fabricate an external butt jointed corner, you will require two 20 mm thick supporting battens screwed vertically to the horizontal framework (Figure 5). Trim off the groove from both panels, and secure to the vertical battens with rust free façade nails 10 mm from the edge and at 75 mm intervals.

Figure 6

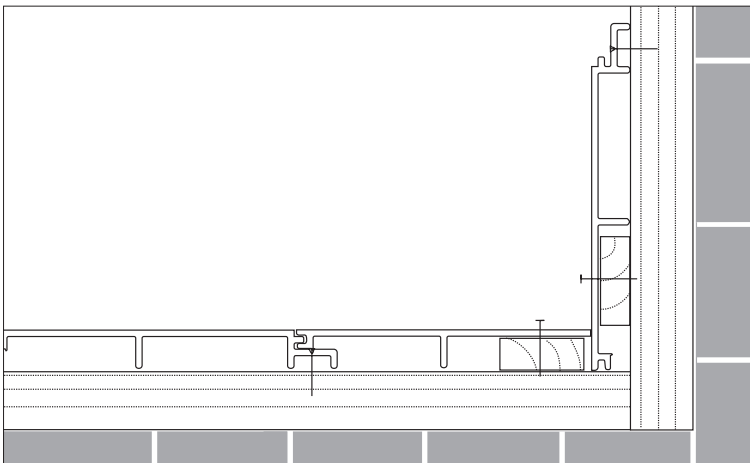

c) Inside corner

To fabricate an internal corner the panels are butted up against each other supported by 20 mm x 30 mm thick vertically mounted battens (Figure 6). Pin to the battens with rust free façade nails 10 mm in from the corner and at 75 mm intervals.

d) Cladding one wall

Should you want to clad only one wall with vinyTherm Stonechip cladding, use the vinyCom window reveal profile (Article number 21.30.11) together with the vinyCom starter profile (Article number 25.60.11) and the vinyCom cover strip 20/2 (Article number 21.02.11) for outside corners (Figure 7, Figure 8). A supporting 20 x 30 mm batten is used, vertical y positioned, in the corner areas and the panels are fixed using rust free façade nails at 100 mm intervals.

Figure 7

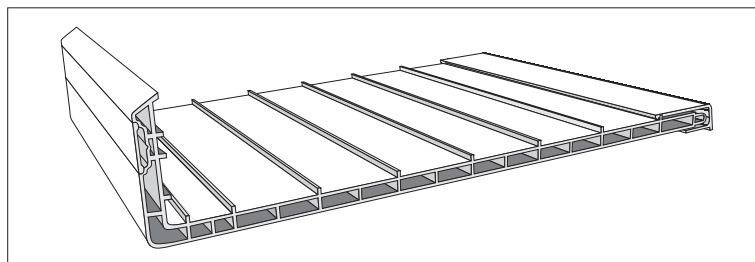
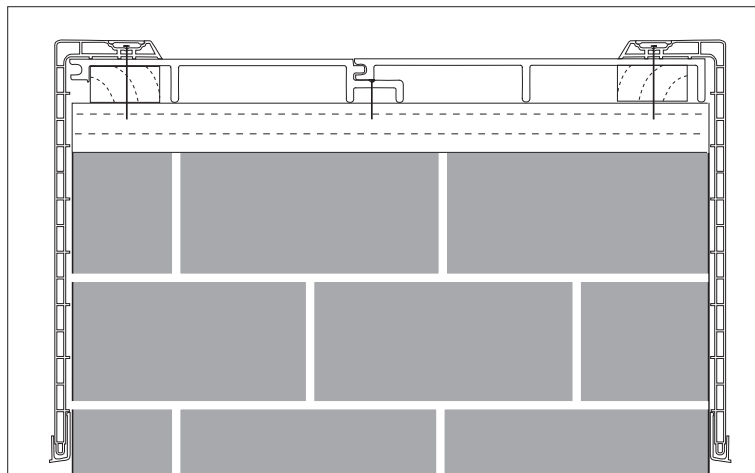
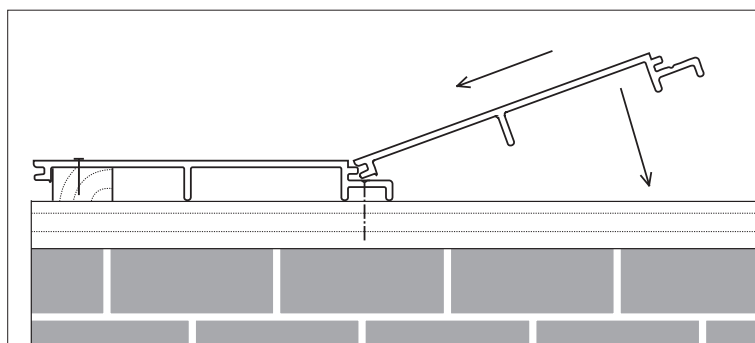

Figure 8



Successive panels are placed in the previous panel using the tongue and groove provided (Figure 9). The panels are eased together, not forced, and fixed by rust proof screws through the tongued section of the panel in the positions provided. The special construction prevents the profiles slipping apart before they have been fastened.

Figure 9



Please note

The fixing screws must be inserted at right angles to the panel (Figure 10) otherwise the panel might buckle.

Figure 10

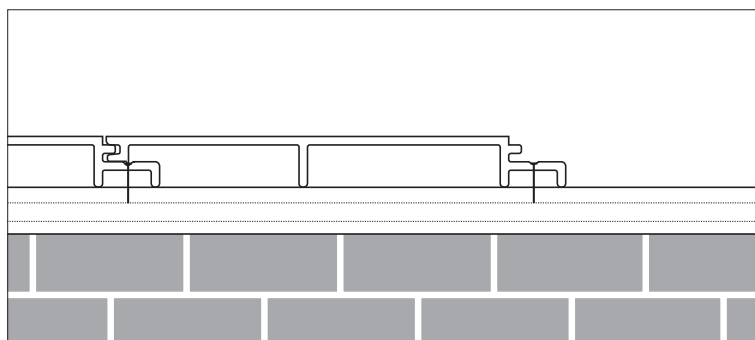

The very nature of the top-quality thermoplastic material used for the production of the panels will expand marginally when there is a change in temperature, even if the expansion cannot be seen by the naked eye. Therefore, the joints should be pressed only slightly together (especially when the installation is done in lower temperatures). This will guarantee that each panel can expand during a temperature rise without distorting.

Do not install at a temperature less than 5 degree Celsius, unless the panels can be conditioned, immediately prior to assembly, to a higher temperature.

Figure 11

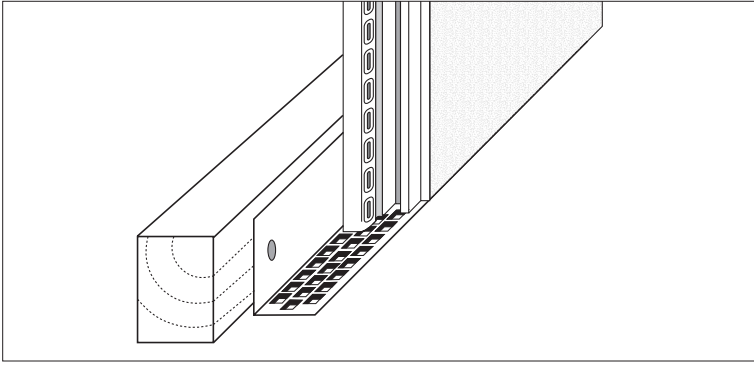

Figure 12

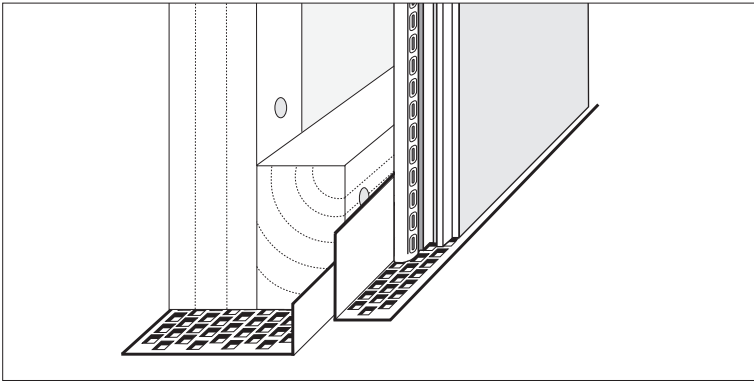

Figure 13

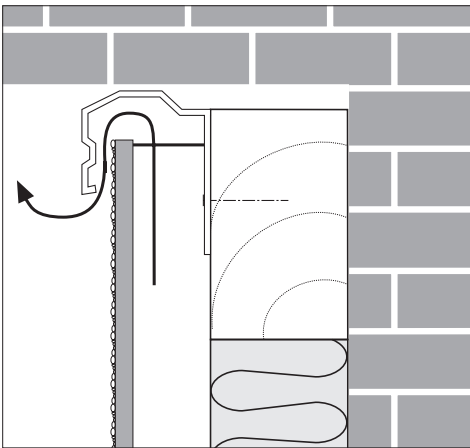
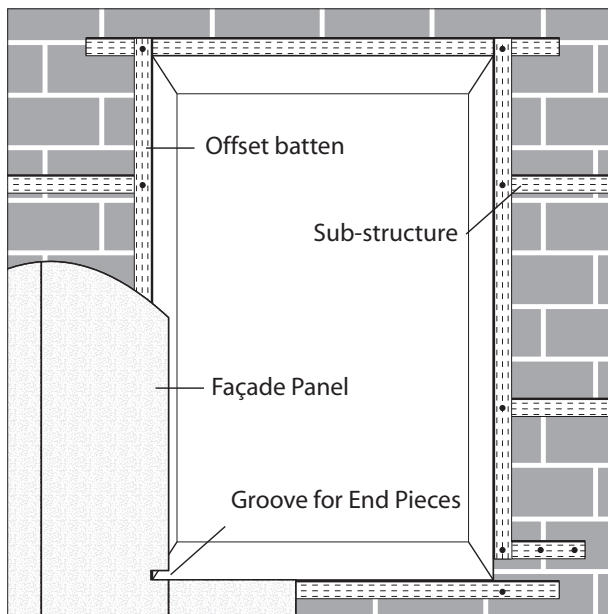

Figure 14



9. Lower Panel Finishing

In order to achieve a neat straight edge the Stonechip panel must be cut absolutely square. Fix a ventilation profile to the bottom framework (Figure 11). (Ventilation profile, 25/50 mm. Article number 50.02.11).

Where double battens are used, a second or additional ventilation profile should be used underneath the framework. This also prevents mice or insects getting into the foundations. Both, the 25 mm vent and the additional ventilation profile can be of PVC or aluminium (Figure 12).

The ventilation must be minimum 50 cm² per 1 m of wall length to ensure sufficient air circulation.

10. Upper Panel Finishing

To finish the upper edge the top vent profile 45/40 (Article number 21.12.11) is to be used (Figure 13).

11. Window Borders

a) Sub construction

One offset batten (20 x 30 mm) has to be arranged for each vertical layer at the sides of the window openings for the fixing of the cladding panels as well as the window reveal profiles to the reveal edges.

In order to avoid dirt lines on the façade, we recommend the use of our windowsill end pieces.

b) Windowsill

The windowsill has to be measured and attached so that the vertical reveal profiles are aligned above the end pieces. The end pieces have to be fitted into the Stonechip panels accordingly (also see: Figure 14).

c) Cutting the Upper Window Reveal

The window reveal is measured and cut according to the present reveal depth: The measuring of the depth starts from the façade surface at the window frame, and approximately 5 mm is subtracted from this depth.

The length of the lintel reveal profile is calculated as follows (Figure 16):

Width between the windowsill end pieces of the fitted windowsill (X)

- 10 mm

= required measurement of the lintel reveal profile

d) Cutting the Side Window Reveal

The length of the side window reveal profile is calculated as follows (Figure 17):

The height between the windowsill and lower edge of the lintel reveal profile (X)
in the area of the façade front

- 6 mm

= required measurement of the side reveal profile

According to the slope of the windowsill, the soffit profile has to be cut diagonally in the bottom area (resources: protractor or similar).

Figure 15

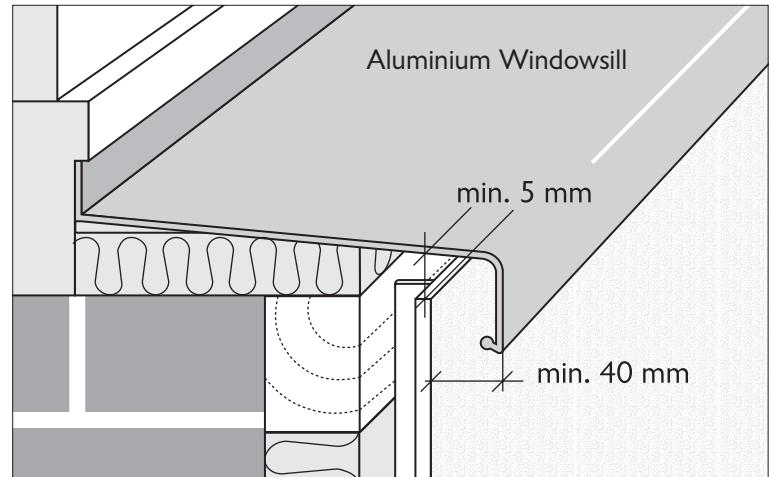

Figure 16

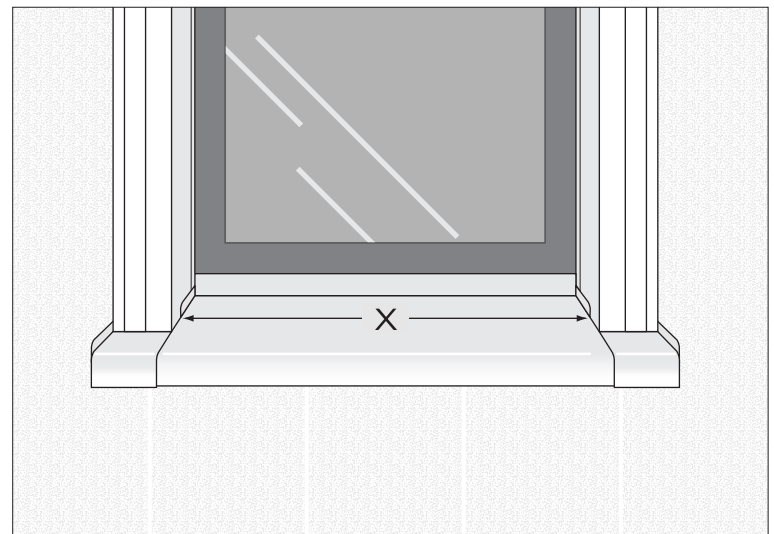

Figure 17

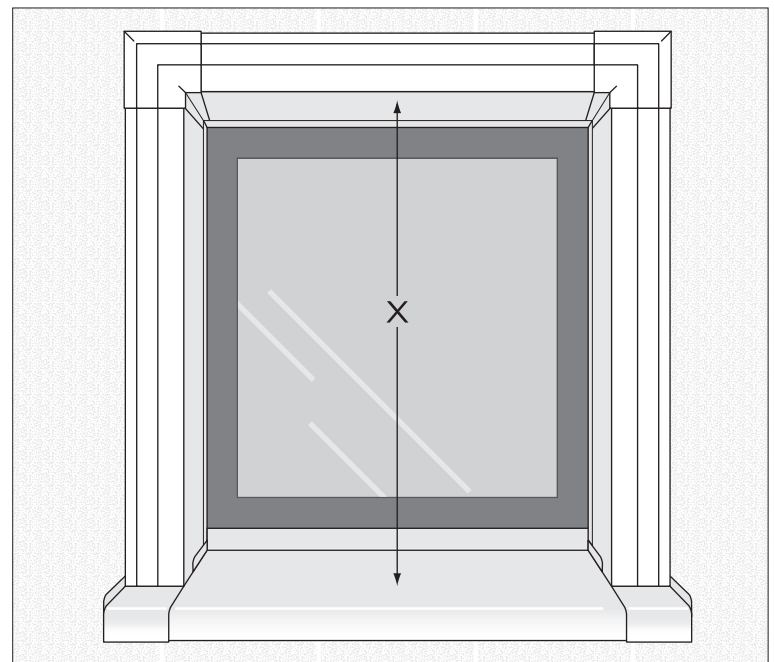

Figure 18

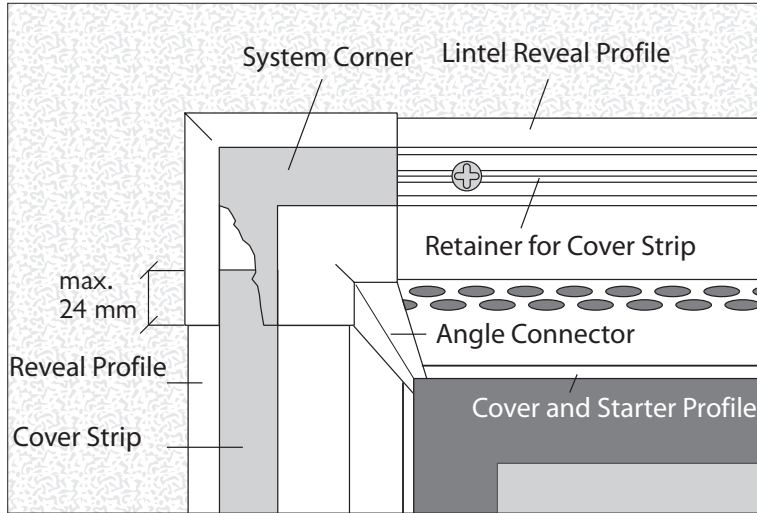

Figure 19

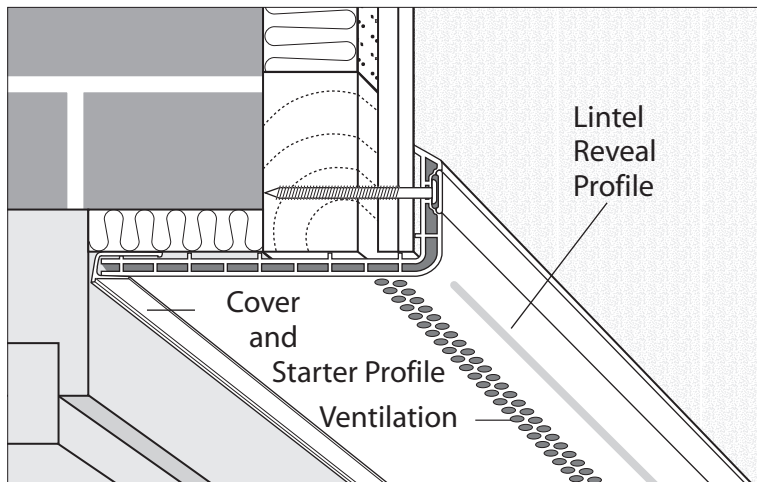
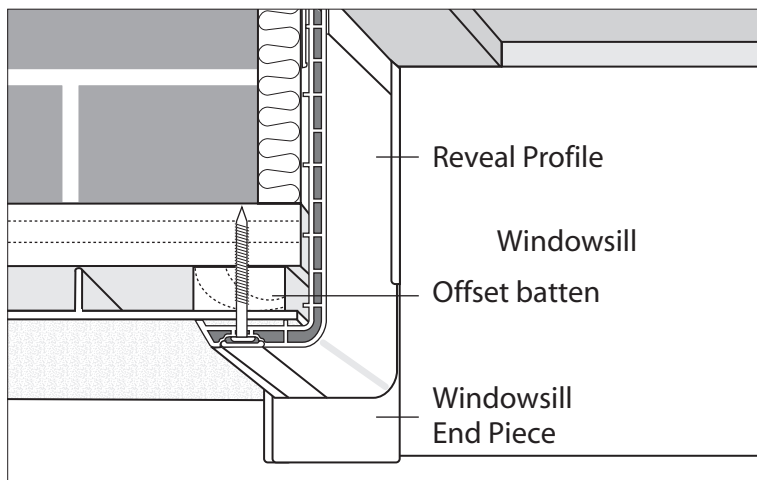

Figure 20



e) Cutting the Angle Connector

The length of the angle connector is measured from the façade surface to the short support of the cover and starter profile. The scaling of the angle connector gives the depth starting from the façade surface.

f) Mounting of the Reveal

The cover and starter profile should be used to connect and fasten to the top and side window frame. The cut reveal profiles are joined with the angle connectors and attached to the reveal as a whole element. The fixing is done with chipboard screws with tallow-drop heads, 4 x 40 mm.

The fixing groove is covered with the cover strip 20/2, which again is held by the clamp effect. It can protrude a maximum 24 mm into the angle connectors.

In order to avoid displacement the cover strip should be glued to the bottom area of the groove of the reveal profile.

Finally, the system corners (which are of the same colour as the cover strip) are clicked into the depression of the angle connectors by light taps with a pin hammer or similar.

g) Enlargement

For reveal depths of more than 290 mm, the extension profile (150 mm, Article number 21.14.11) has to be stuck to the reveal profile 280/55 and the lintel reveal profile 280/55.

The installation procedure is the same as in the previous description.

h) Processing

- Circular or pad saw with a fine blade for plastics
- Angle grinder
- Fine saw with hardened teeth

Dark window reveals should not be used for visual reasons and because it obstructs the entrance of the light into the interior. The supplier does not accept any liability for the constancy of the colour of any brown accessory profiles.

Figure 21

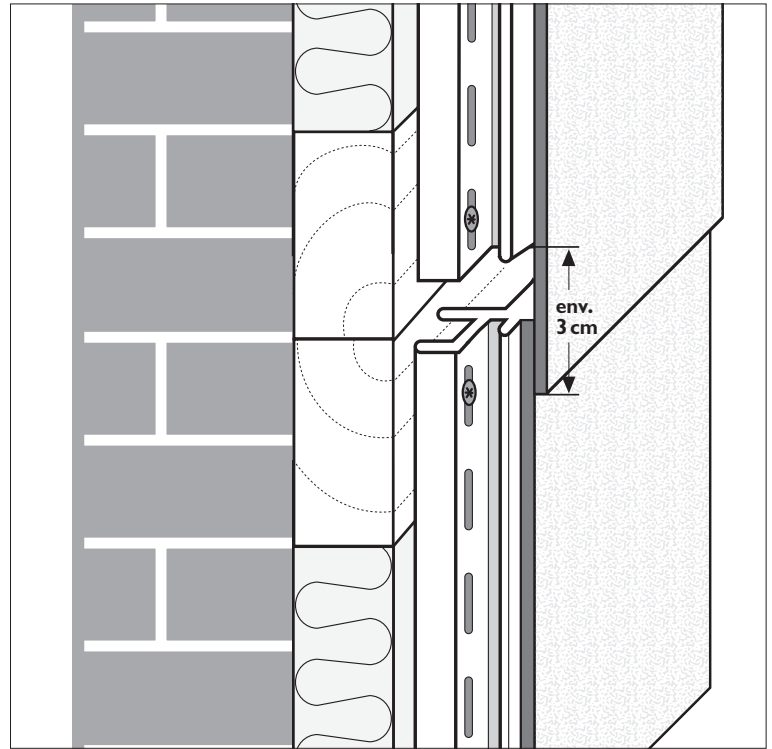

12. Expansion Joints

vinylTherm Stonechip panels are 600 cm long. When cladding high buildings joints are necessary. We recommend joint formation by overlapping (Figure 21). For this it is essential to remove ca. 3 cm of the legs at the back of the overlapping panel. This panel should be mounted in such a way as to overlap the lower panel by 1.5 cm. This allows an expansion zone. At the same time through ventilation is guaranteed.

Figure 22

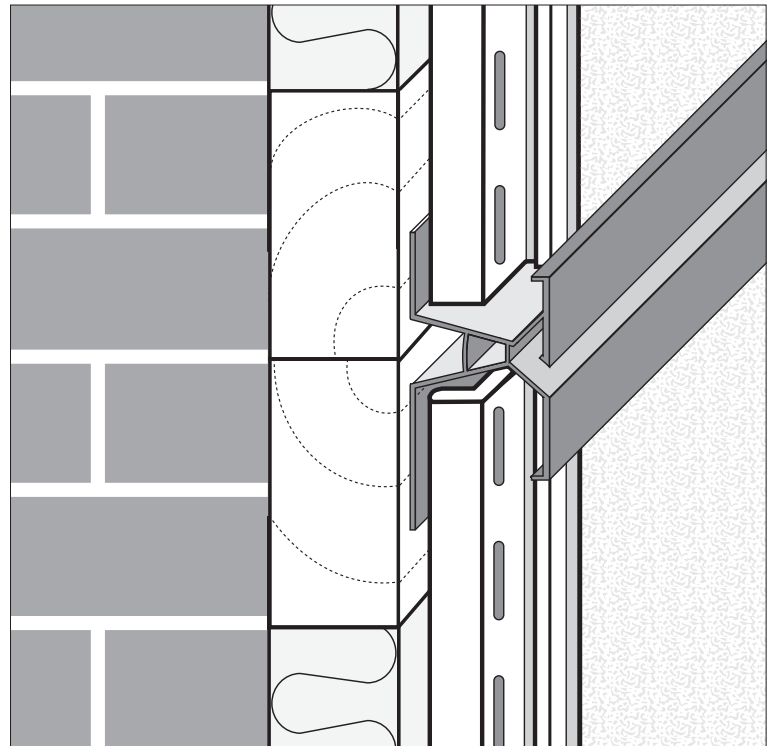

The technically better solution is the use of the X-profile 45/60 (Article number 21.03.11) with drainage channel. Insert the Stonechip panels into the joint sections (X-profile) so that both the cut edge and expansion joint are totally covered (Figure 22). The drainage holes should be at the top.

Important

With a temperature change of 10 °C vinylTherm Stonechip panels shrink/ expand by 0.7 mm per meter. This corresponds to a shrinkage or expansion of 4.2 mm for a panel 600 cm long.

Figure 23



Figure 24



Figure 25

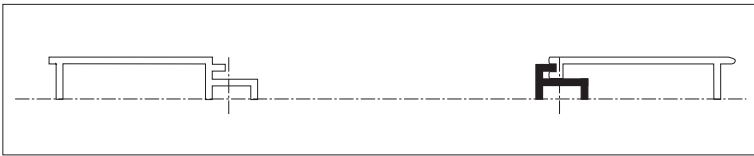

Figure 26

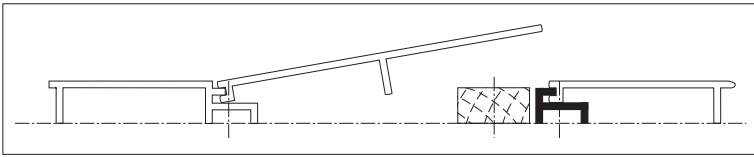
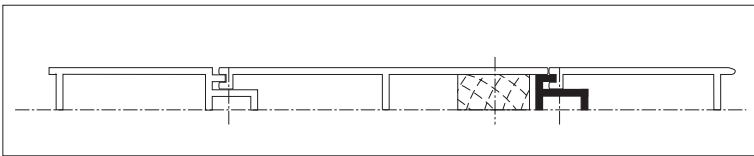

Figure 27



13. Replacing Individual Panels

Just as straight forward as the assembly is the changing of individual panels. The panel to be changed is cut out with a sharp blade (Figures 23, 24).

The grooved side of the panel can be removed, but the tongued section serves as a support for a new section (Figure 25).

Cut away the top section of the tongued area with a sharp knife. A 20 mm support batten should now be affixed to the wall adjacent to the tongued section of the removed panel. This will support the new panel.

Insert the groove of the new panel into the tongued area of the adjacent panel (Figure 26).

Final assembly (Figure 27) occurs by using rust free façade nails (1.9 x 27 mm, Article number 51.04.02).

This installation instruction represents the manufacturers recommendation for installation only. Whilst all reasonable care is taken in compiling technical information, all recommendations regarding the use of products are made without guarantee since the conditions of use are beyond the control of Vinylit. It is the users responsibility to satisfy himself that each product is fit for the purpose for which he intends to use it and that the actual conditions of use are suitable.

The installer is obliged to check regarding the latest installation instruction and to consider the accepted technology rules, the regulations for facade mounting and the national standards.



A SURTECO COMPANY

Vinylit Fassaden GmbH
Gobietstraße 10
D-34123 Kassel
Telefon +49 (0)561/9591-333
Fax +49 (0)561/9591-302
e-mail info@vinylit.de
Internet www.vinylit.com